

REVISION RECORD

REV	ECN	DESCRIPTION	DRFT	DATE
-----	-----	-------------	------	------

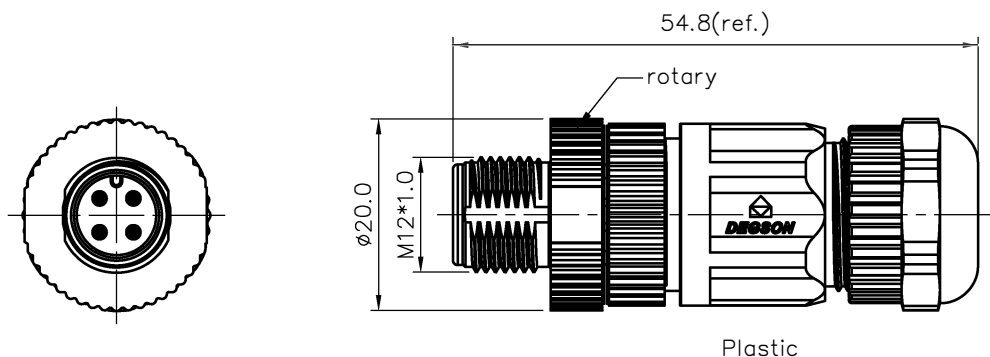

NOTES:

- Rated voltage/current : 3pin A: 250V / 4A
4pin A: 250V / 4A
5pin A: 60V / 4A
6pin A: 30V / 2A
8pin A: 30V / 2A
5pin B: 60V / 4A
4pin D: 250V / 4A
- Withstanding voltage : 3,4pin A: AC1500V/1Min
5pin A: AC1120V/1Min
6,8pin A: AC500V/1Min
5pin B: AC1120V/1Min
4pin D: AC1500V/1Min
- Levels of protection: IP67
- Wire range :
3pin A: 24~20AWG/0.25~0.52mm²
4pin A: 24~20AWG/0.25~0.52mm²
5pin A: 24~20AWG/0.25~0.52mm²
6pin A: 24~22AWG/0.25~0.34mm²
8pin A: 24~22AWG/0.25~0.34mm²
5pin B: 24~20AWG/0.25~0.52mm²
4pin D: 24~20AWG/0.25~0.52mm²

5pin B Coding 4pin D Coding

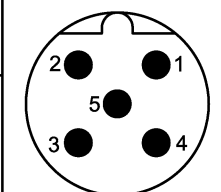

Pin Assignments Front View

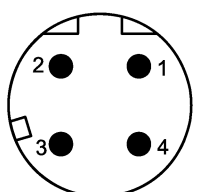

Pin Assignments Front View

PW-M12X-XXP-MM-SL7001-00A(H)
Coding: A, B, D
Pin number: 03,04,05, 06,08

3pin A Coding 4pin A Coding 5pin A Coding 6pin A Coding 8pin A Coding

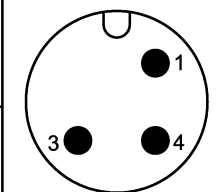

Pin Assignments Front View

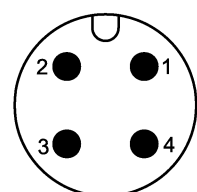

Pin Assignments Front View

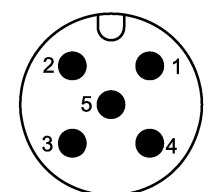

Pin Assignments Front View

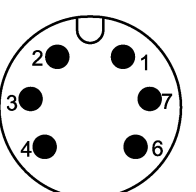

Pin Assignments Front View

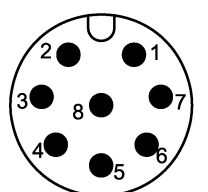

Pin Assignments Front View

- Cable OD: 4~8mm
- Wire connection mode: screw
- Operating temperature: -25°C~+105°C
- RoHS Compliance
- Tolerance : ±0.5mm

DETACHED LISTS	PART NO.: PWM12XXXPMMSL7001 00AH	宁波高松电子有限公司 NINGBO DEGSON ELECTRICAL CO., LTD		
	APPD:	NAME: PW-M 12X-XXP-MM-SL 7001-00A(H)		
	CHKD:	DRFT: SQ 2019.05.17		
	THIRD ANGLE PROJECTION		TITLE: CUSTOMER DRAWING REV: D0-1 DRAWING NO.: XXXXXXXX-XX-CXX SHEET: 1/1 DO NOT SCALE DRAWING SCALE: 1:1	