

# GRM31CE70G476ME15#

"#" indicates a package specification code.



< List of part numbers with package codes >  
 GRM31CE70G476ME15L , GRM31CE70G476ME15K

## Shape

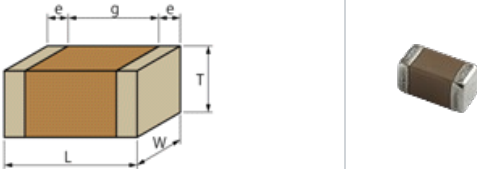

L size	3.2 ±0.2mm
W size	1.6 ±0.2mm
T size	1.6 ±0.2mm
External terminal width e	0.3 to 0.8mm
Distance between external terminals g	1.5mm min.
Size code in inch(mm)	1206 (3216M)

## References

Packaging	Specifications	Minimum quantity
L	φ 180mm Embossed taping	2000
K	φ 330mm Embossed taping	6000

Mass (typ.)	
1 piece	52.0mg
φ 180mm Reel	144g

## Specifications

Capacitance	47μF ±20%
Rated voltage	4Vdc
Temperature characteristics (complied standard)	X7U(EIA)
Capacitance change rate	+22.0/-56.0%
Temperature range of temperature characteristics	-55 to 125°C
Operating temperature range	-55 to 125°C

### ⚠ Attention

- 1.This datasheet is downloaded from the website of Murata Manufacturing Co., Ltd. Therefore, it's specifications are subject to change or our products in it may be discontinued without advance notice. Please check with our sales representatives or product engineers before ordering.
- 2.This datasheet has only typical specifications because there is no space for detailed specifications. Therefore, please review our product specifications or consult the approval sheet for product specifications before ordering.

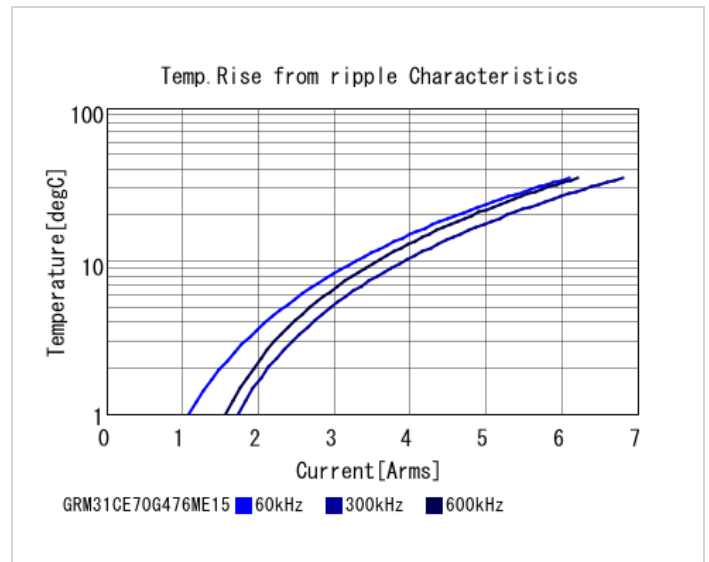
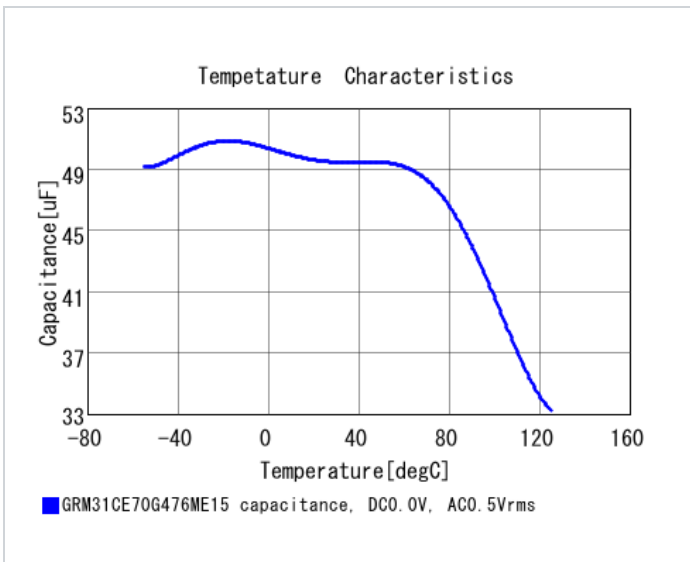
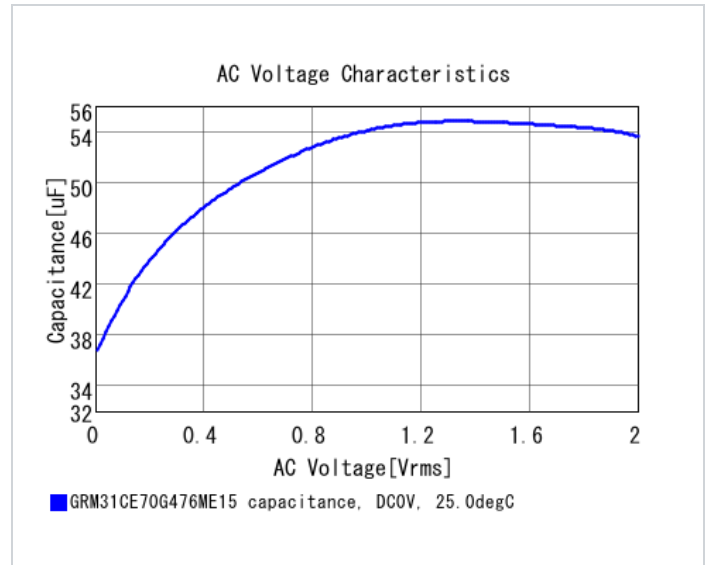
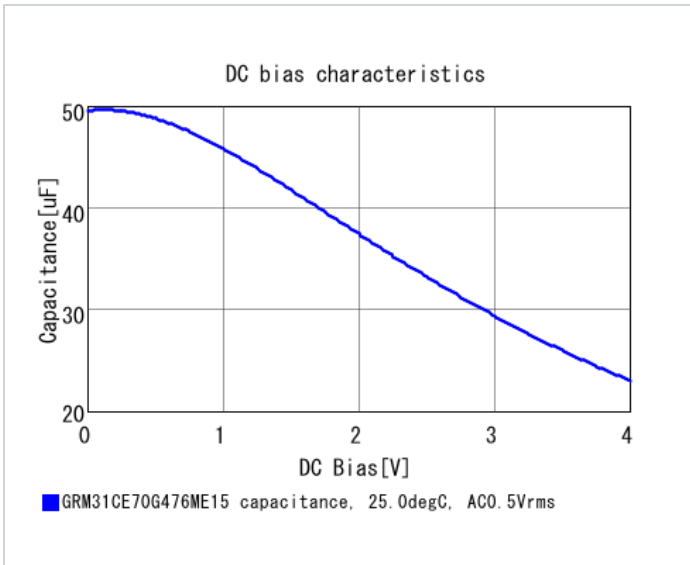
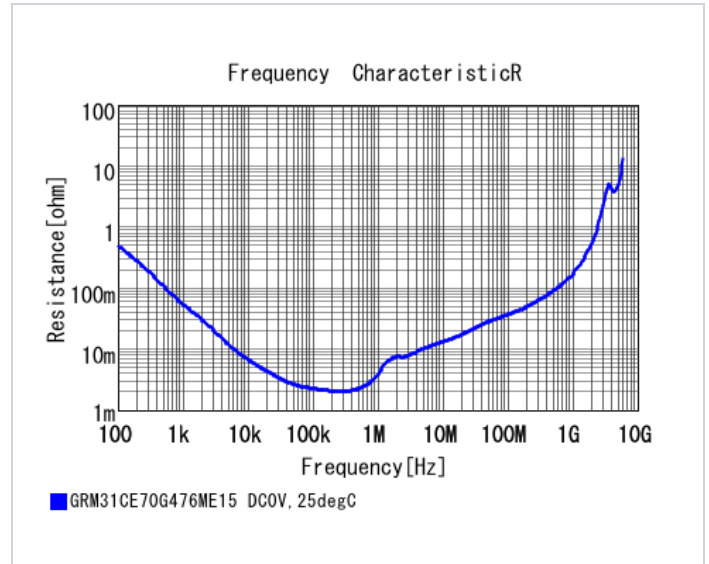
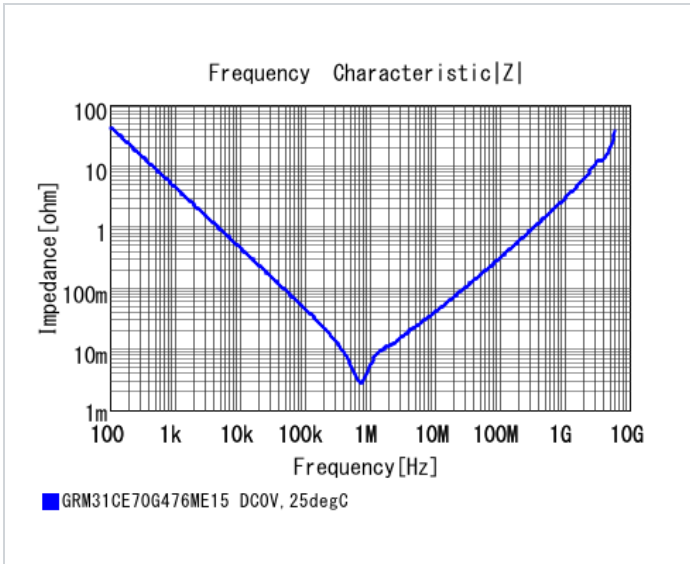

**⚠ Attention**

- 1.This datasheet is downloaded from the website of Murata Manufacturing Co., Ltd. Therefore, it's specifications are subject to change or our products in it may be discontinued without advance notice. Please check with our sales representatives or product engineers before ordering.
- 2.This datasheet has only typical specifications because there is no space for detailed specifications. Therefore, please review our product specifications or consult the approval sheet for product specifications before ordering.