

## 1200V, 450A IGBT Module

### ■ 特点/Features

- 低 Vcesat/ Low Vcesat
- 高可靠性和功率密度/High reliability and Power density
- 低开关损耗/Low switching loss

### ■ 应用领域/Applications

- UPS 系统/UPS Systems
- 风力发电机/Wind Tuebines
- 电机传动/Motor Drives

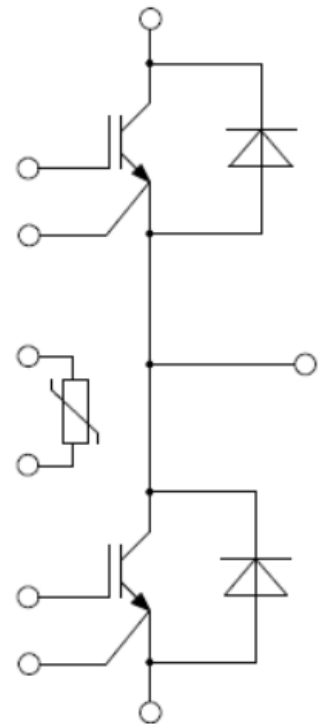

Vces=1200V

Ic nom =450A

## ● IGBT-逆变器/IGBT- Inverter

### 最大额定值/Absolute Max Ratings

符号 Symbol	参数 Parameter	条件 condition	值 Value	单位 Units
$V_{CES}$	Collector-to-Emitter Voltage 集电极-发射极电压	$T_{vj}=25\text{ }^{\circ}\text{C}$	1200	V
$I_{C\text{ nom}}$	Continuous DC collector current 连续集电极直流电流	$T_C = 100^{\circ}\text{C}, T_{vj\text{ max}}=175\text{ }^{\circ}\text{C}$	450	A
$I_{CRM}$	Repetitive peak collector current 集电极重复峰值电流	$t_p=1\text{ms}$	900	A
$P_{total}$	Total power dissipation 总功率损耗	$T_C = 25^{\circ}\text{C}, T_{vj\text{ max}}=175\text{ }^{\circ}\text{C}$	2150	W
$V_{GES}$	Gate-Emitter peak voltage 栅极-发射极峰值电压		+/- 20	V

### 特征值/Characteristics Values

符号 Symbol	参数 Parameter	测试条件 Test conditions	Value值			单位 Units
			Min. 最小	Typ. 典型	Max. 最大	
$V_{CE(sat)}$	Collector-Emitter Saturation voltage 集电极-发射极饱和电压	$V_{GE}=15\text{V}, I_C=450\text{A}, T_{vj}=25^{\circ}\text{C}$	—	1.75	—	V
		$V_{GE}=15\text{V}, I_C=450\text{A}, T_{vj}=150^{\circ}\text{C}$	—	2.05	—	V
$V_{GE(th)}$	Gate threshold voltage 门极开启阈值电压	$V_{GE} = V_{CE}, I_C = 17\text{mA}$	5	5.6	6.2	V
$C_{iss}$	Input capacitance 输入电容	$V_{GE} = 0\text{V}$ $V_{CE} = 25\text{V}$ $T_{vj} = 25^{\circ}\text{C}$ $f = 1\text{MHz}$	—	30.5	—	nF
$C_{oss}$	Output capacitance 输出电容		—	2.75	—	nF
$C_{riss}$	Reverse transfer capacitance 反向传输电容		—	1.0	—	nF
$Q_g$	Total gate charge 栅极电荷	$V_{GE} = -15\text{.....}+15\text{V}$	—	1.62	—	$\mu\text{C}$
$R_g$	Internal gate resistor 内部栅极电阻	$T_{vj}=25^{\circ}\text{C}$	—	2.30	—	$\Omega$
$I_{CES}$	Collector-Emitter leakage current 集电极-发射极截止电流	$V_{CE}=1200\text{V},$ $V_{GE} = 0\text{V}, T_{vj}=25^{\circ}\text{C}$	-	-	5.0	mA
$I_{GES}$	Gate-Emitter leakage current 栅极-发射极漏电流	$V_{CE}=0\text{V}, V_{GE} = 20\text{V}, T_{vj}=25^{\circ}\text{C}$	-	-	500	nA
$T_{d(on)}$	Turn-On Delay Time 开通延迟时间	$T_{vj}=25^{\circ}\text{C}, V_{CE}=600\text{V},$ $I_C=450\text{A}, R_g=1.0\text{ohm},$ $V_{GE}=+15\text{V}$	-	180	-	ns
$T_r$	Rise Time 上升时间		-	59	-	ns

$T_{d(off)}$	Turn-Off DelayTime 关断延迟时间	$T_{vj}=150^{\circ}C, V_{CE}=600V,$ $I_c=450A, R_g=1.0\Omega,$ $V_{GE}=+15V$	-	435	-	ns
$T_f$	Turn-Off Fall Time 下降时间		-	82	-	ns
$T_{d(on)}$	Turn-On DelayTime 开通延迟时间		-	187	-	ns
$T_r$	Rise Time 上升时间		-	66	-	ns
$T_{d(off)}$	Turn-Off DelayTime 关断延迟时间		-	504	-	ns
$T_f$	Turn-Off Fall Time 下降时间		-	218	-	ns
$E_{on}$	Turn-on switch loss 开通损耗	$T_{vj}=25^{\circ}C, V_{CE}=600V,$ $I_c=450A, R_g=1.0\Omega,$ $V_{GE}=+15V$	-	21	-	mJ
$E_{off}$	Turn-off switch loss 关断损耗		-	43	-	mJ
$E_{on}$	Turn-on switch loss 开通损耗	$T_{vj}=150^{\circ}C, V_{CE}=600V,$ $I_c=450A, R_g=1.0\Omega,$ $V_{GE}=+15V$	-	36	-	mJ
$E_{off}$	Turn-off switch loss 关断损耗		-	51	-	mJ
$I_{sc}$	Short-circuit current 短路电流	$T_{vj}=25^{\circ}C, V_{GE}=15V,$ $V_{CE}=1000V, t_p < 10\mu s$	-	2400	-	A
$R_{thJC}$	Junction-Case Thermal resistance 结-外壳热阻	-	-	-	0.07	K/W
$T_{vj op}$	Temperature under switching 在开关状态下温度	-	-40	-	150	$^{\circ}C$

## ● 二极管-逆变器/Diode- Inverter

### 最大额定值/Absolute Max Ratings

符号 Symbol	参数 Parameter	条件 condition	值 Value	单位 Units
$V_{RRM}$	Repetitive peak reversevoltage 反向重复峰值电压	$T_{vj}=25^{\circ}C$	1200	V
$I_F$	Continuous DC forward current 连续正向直流电流		450	A
$I_{FRM}$	Repetitive peak forward current 正向重复峰值电流	$T_p=1ms$	900	A

### 特征值/Characteristics Values

符号 Symbol	参数 Parameter	测试条件 Test conditions	Value值			单位 Units
			Min. 最小	Typ. 典型	Max. 最大	
V <sub>F</sub>	Forward voltage 正向电压	I <sub>F</sub> =450A, T <sub>vj</sub> =25 °C	-	2.32	-	V
		I <sub>F</sub> =450A, T <sub>vj</sub> =150 °C	-	2.40	-	V
I <sub>RM</sub>	Peak reverse recovery current 反向恢复峰值电流	I <sub>F</sub> =450A, V <sub>R</sub> =600V, T <sub>vj</sub> =25 °C	-	243	-	A
Q <sub>r</sub>	Recovery charge 恢复电荷		-	21	-	uC
E <sub>rec</sub>	Reverse recovery energy 反向恢复损耗		-	11	-	mJ
I <sub>RM</sub>	Peak reverse recovery current 反向恢复峰值电流	I <sub>F</sub> =450A, V <sub>R</sub> =600V, T <sub>vj</sub> =150 °C	-	318	-	A
Q <sub>r</sub>	Recovery charge 恢复电荷		-	53	-	uC
E <sub>rec</sub>	Reverse recovery energy 反向恢复损耗		-	24	-	mJ
R <sub>ThJC</sub>	Junction-Case Thermal resistance 结-外壳热阻		-	-	0.05	K/W
T <sub>VJ OP</sub>	Temperature under switching 在开关状态下温度		-40	-	150	°C

### ● 负温度系数热敏电阻/ NTC- Thermistor

#### 特征值/Characteristics Values

符号 Symbol	参数 Parameter	测试条件 Test conditions	Value值			单位 Units
			Min. 最小	Typ. 典型	Max. 最大	
R <sub>25</sub>	Rated Resistance 额定电阻值	T <sub>C</sub> = 25 °C		5.0		kΩ
ΔR/R	Deviation for R100 R100 偏差	T <sub>C</sub> = 25 °C, R100=493Ω	-5	-	5	%
P <sub>25</sub>	Power dissipation 耗散功率	T <sub>C</sub> = 25 °C	-	20	-	mW
B <sub>25/50</sub>	B-value B-值	$R_2=R_{25}\exp[B_{25/50}(1/T_2-1/(298,15K))]$	-	3375	-	K

## ● 模块/Module

### 模块参数/Module parameter

符号 Symbol	参数 Parameter	测试条件 Test conditions	Value值			单位 Units
			Min. 最小	Typ. 典型	Max. 最大	
V <sub>ISOL</sub>	Isolation voltage 绝缘测试电压	RMS,f=50Hz,t=1min	-	2.5	-	kV
	Material of Base plate 模块基板材料		-	Cu	-	
	Internal Isolation 内部绝缘	Basic insulation (class1,IEC61140)	-	Al <sub>2</sub> O <sub>3</sub>	-	
R <sub>thCH</sub>	Junction to heatsink, Thermal Resistance 外壳-散热器热阻		-	0.009	-	K/W
L <sub>s CE</sub>	Stray induction module 杂散电感,模块		-	25	-	nH
R <sub>CC'+EE'</sub>	Module lead resistance 模块引线电阻,端子-芯片	T <sub>C</sub> = 25 °C	-	1.5	-	mΩ
T <sub>STG</sub>	Storage Temperature 储存温度		-40	-	+150	°C
M	Mounting torque for modul mounting 模块安装的安装扭距	Mounting to heat sink M5	3.0	-	6.0	Nm
	Terminal connection torque 端子联接扭距	Main Terminal M6	3.0	-	6.0	Nm
G	Weigh 重量		-	350	-	g

## ● 特征曲线/ Characteristic Curve



图 1: 输出特性@150°C/ Typical Output Characteristic @150°C



图 2: 输出特性@/ Typical Output Characteristic

$V_{cc}=600V, I_c=450A, V_{ge}=15V, R_g=1.0\Omega$

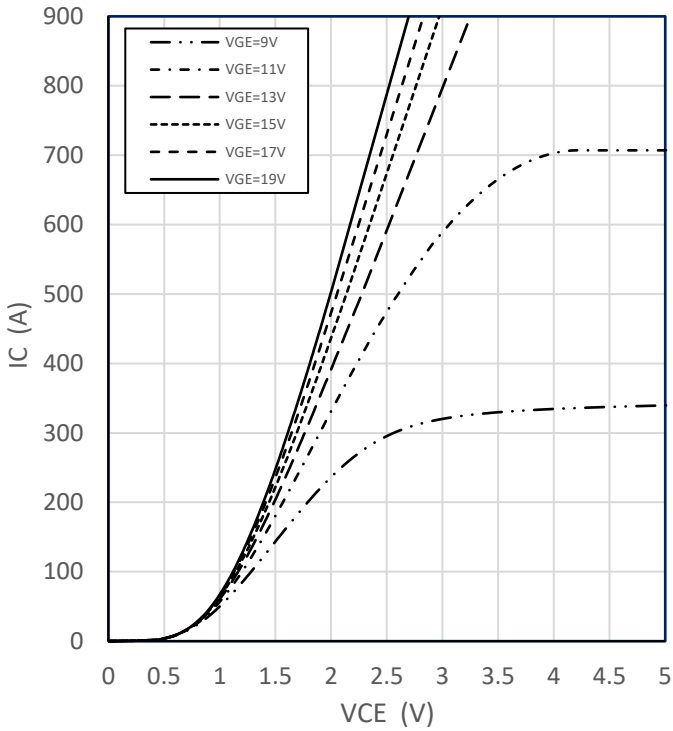

图 3: 传输特性/ Transfer Characteristic

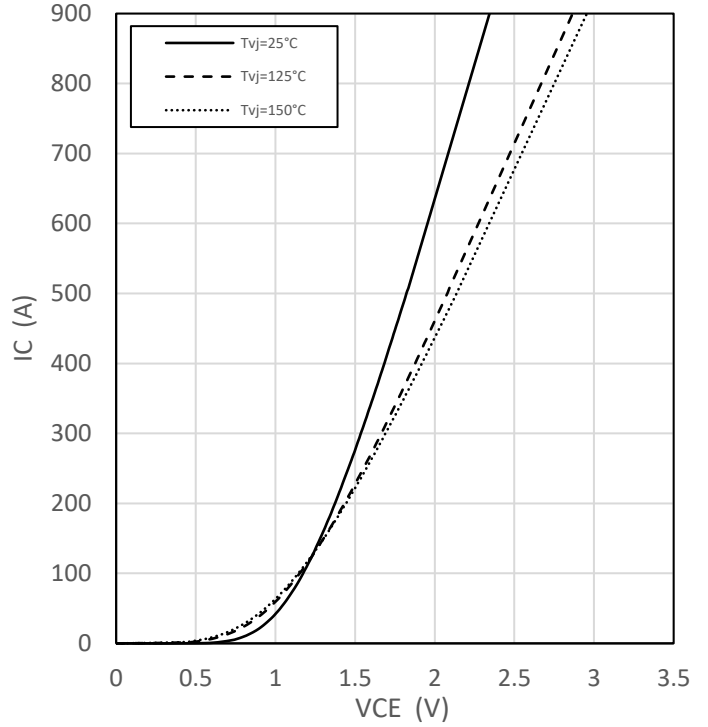

图 4: 动态损耗-温度特性/Typical switching losses as  $T_j$

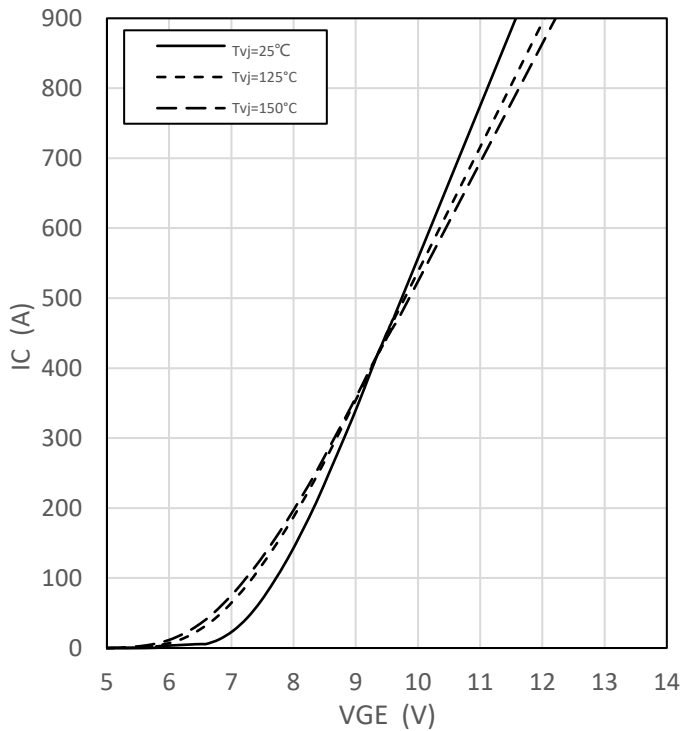

图 5: 动态损耗-电流特性/Typical switching losses as  $I_C$

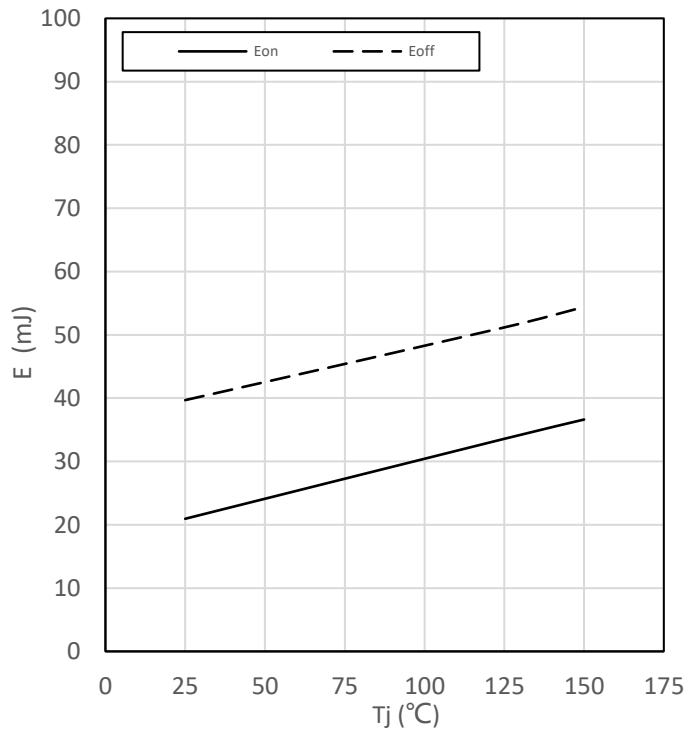

图 6: 动态损耗-门极电阻特性/Typical switching losses as  $R_G$

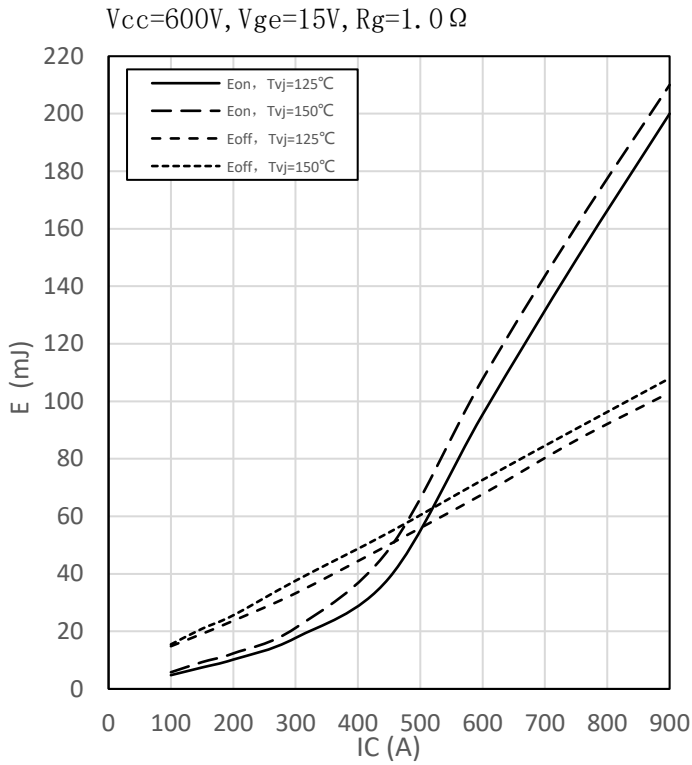

图 7: 二极管压降/Typical  $I_F$  as a function of  $V_F$

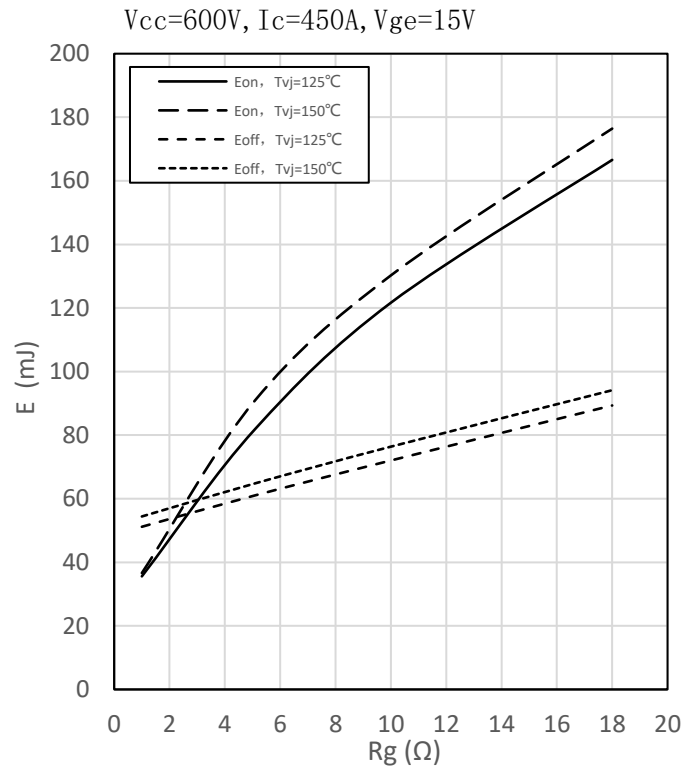

图 8: 反向恢复损耗-电流/Typical  $E_{REC}$  as a function of  $I_C$

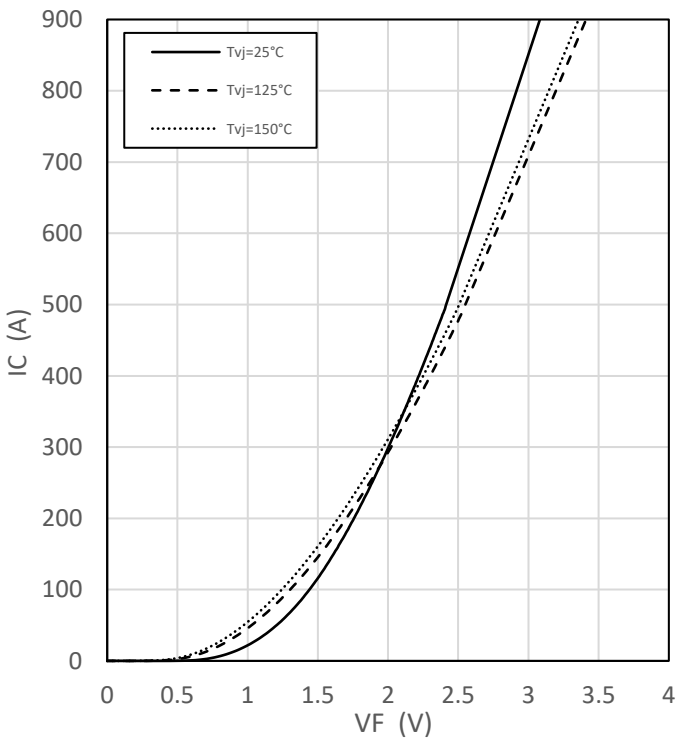

图 9: 反向恢复损耗-门极电阻特性/Typical EREC as a function of R<sub>g</sub>

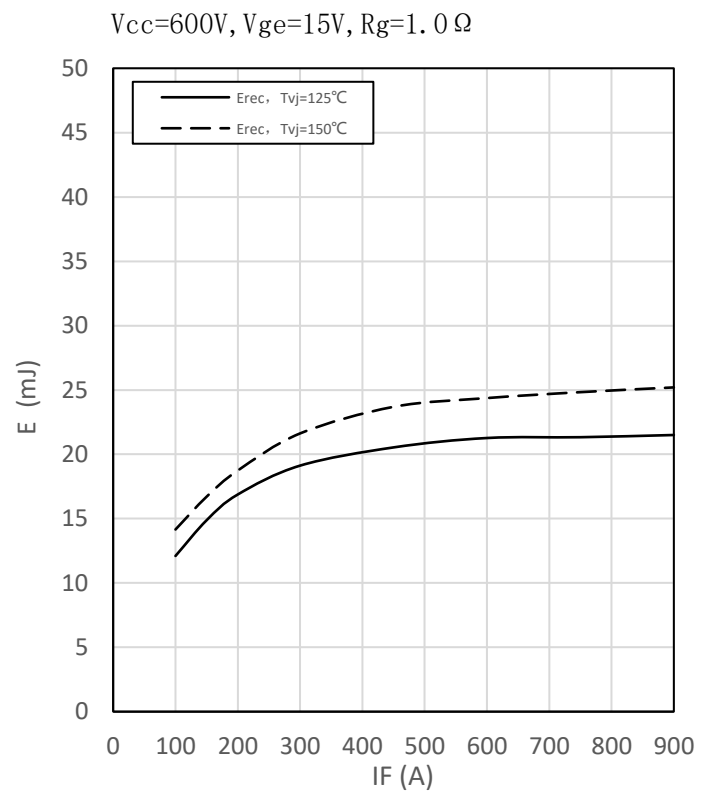

图 10: 热敏电阻特性/NTC Temperature Characteristic

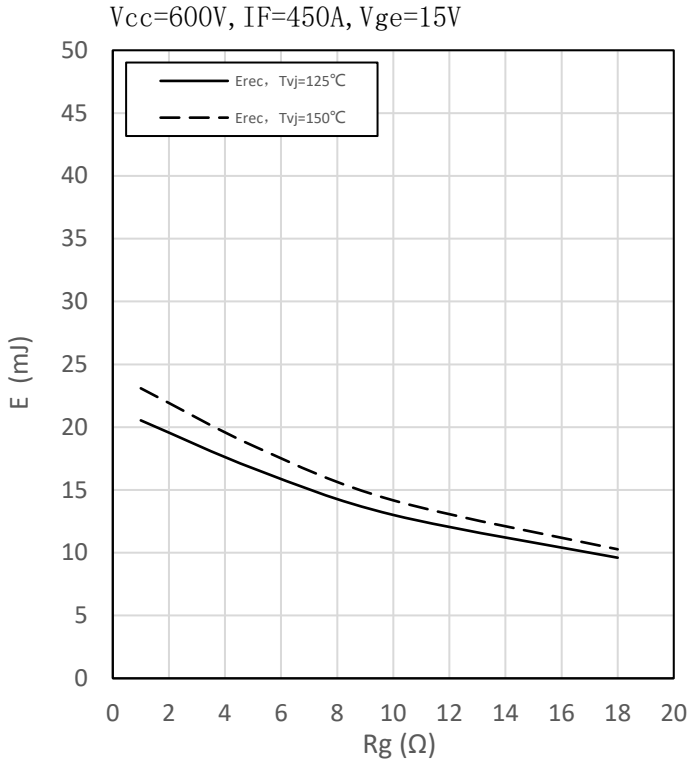

图 11: IGBT 瞬态热阻抗/IGBT Transient Thermal Impedance

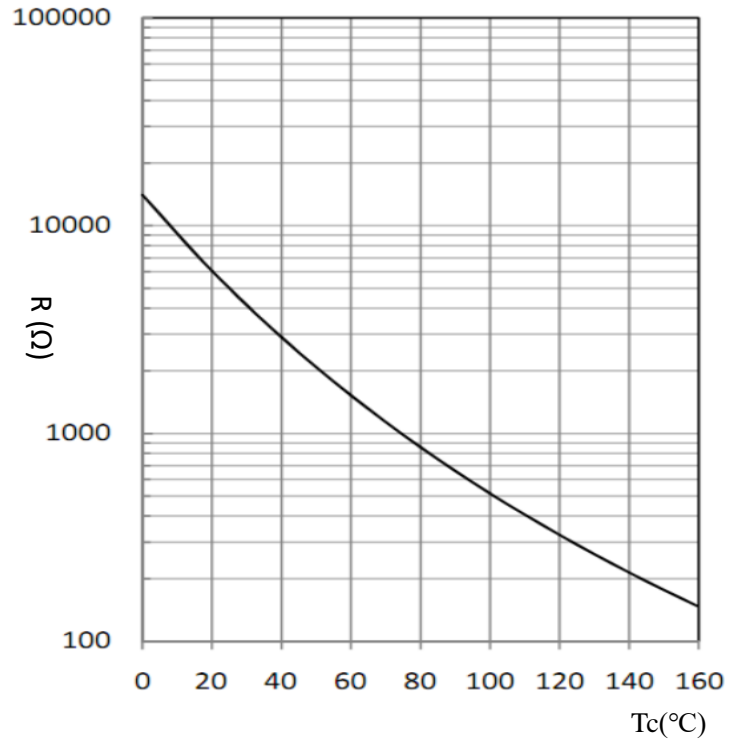

图 12: 二极管瞬态热阻抗/Diode Transient Thermal Impedance



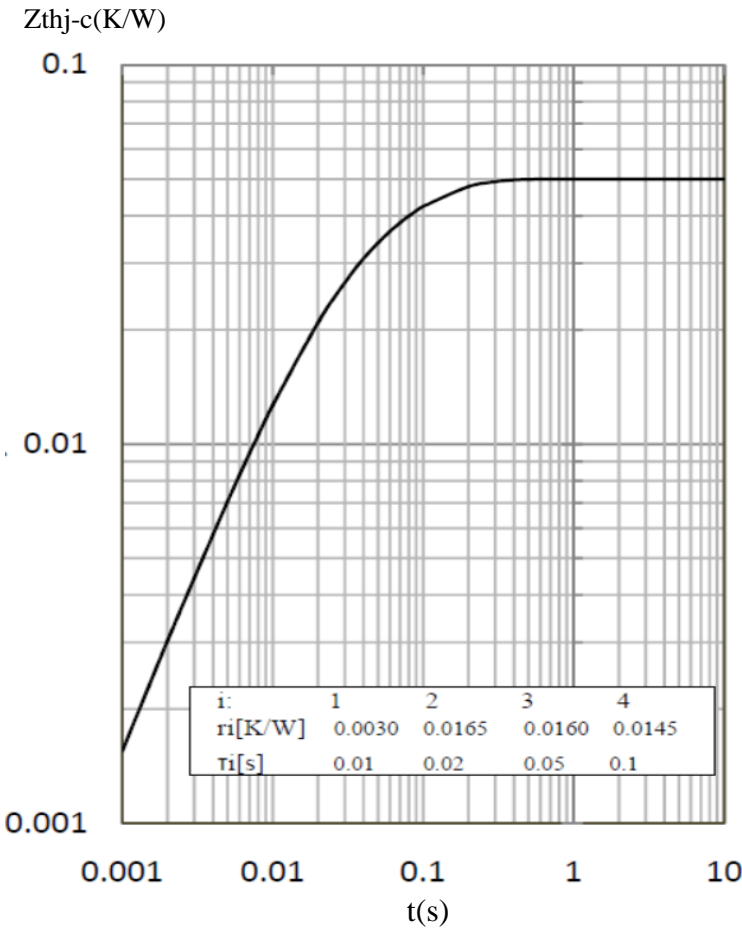

## ● 注意/ Attention

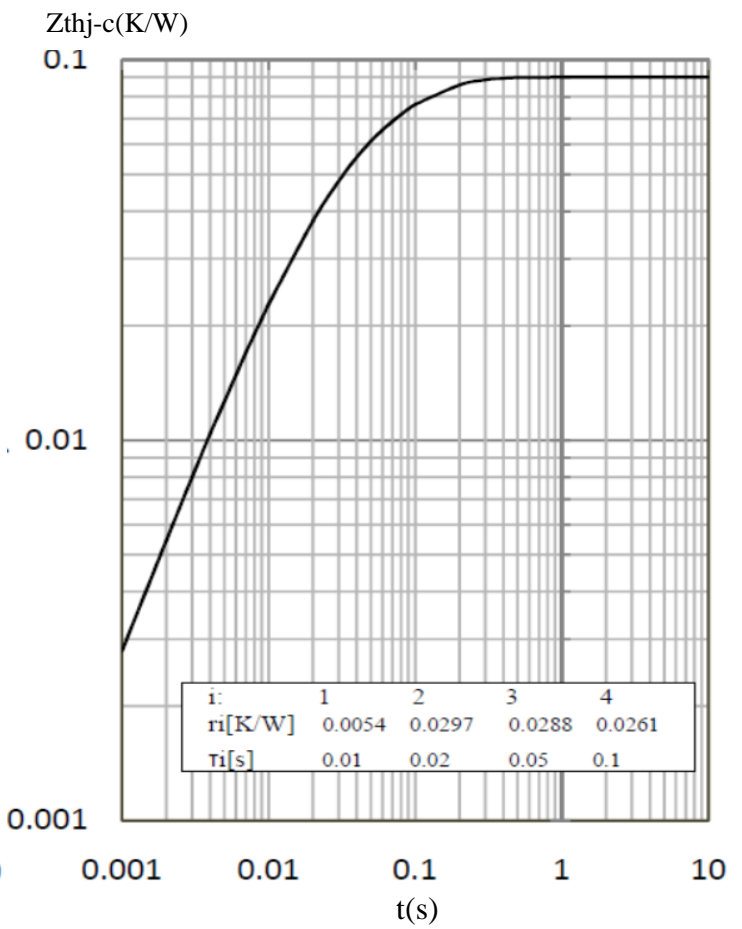
---

- 本文所述芯能产品规定了产品在各状态下的性能、特点和功能，并不保证所述产品安装在客户产品或设备中的性能、特点和功能。为了保证芯能产品在客户产品中工作状态，客户应严谨评估和测试。Specifications of any and all Invsemi products described or contained herein stipulate the performance, characteristics, and functions of the described products in the independent state, and are not guarantees of the performance, characteristics, and functions of the described products as mounted in the customer's products or equipment. To verify symptoms and states that cannot be evaluated in an independent device, the customer should always evaluate and test devices mounted in the customer's products or equipment.
- 本产品在使用过程中，如应用条件超出本规格书规定值（如最大额定值、工作条件范围或其他参数），即使是短时超过，而引起使用该产品的设备出现故障，芯能不承担任何责任。Invsemi assumes no responsibility for equipment failures that result from using products at values that exceed, even momentarily, rated values (such as maximum ratings, operating condition ranges, or other parameters) listed in products specifications of any and all Silicon products described or contained herein.
- 由于产品/技术改进等原因，本文所述或包含的任何和所有信息可能会发生更改，恕不另行通知。Any and all information described or contained herein are subject to change without notice due to product/technology improvement, etc.