

25x25x10 mm

3.0~3.5 CFM



■ Specifications

	Bearing	Rating Voltage	Power Current	Power Consumption	Speed	Air Flow	Static Pressure	Noise	Weight	Curve
	● VAPO	(VDC)	(mA)	(WATTS)	(RPM)	(CFM)	(Inch-H ₂ O)	(dB(A))	(g)	
MC25100V1-000U-A99	●	5	120	0.60	13000	3.5	0.25	23.0	7.5	1
MC25100V2-000U-A99	●	5	85	0.43	10000	3.0	0.18	16.0	7.5	2
MC25101V1-000U-A99	●	12	57	0.69	13000	3.5	0.25	23.0	7.5	1
MC25101V2-000U-A99	●	12	37	0.45	10000	3.0	0.18	16.0	7.5	2

■ Air Flow-Static Pressure Characteristics

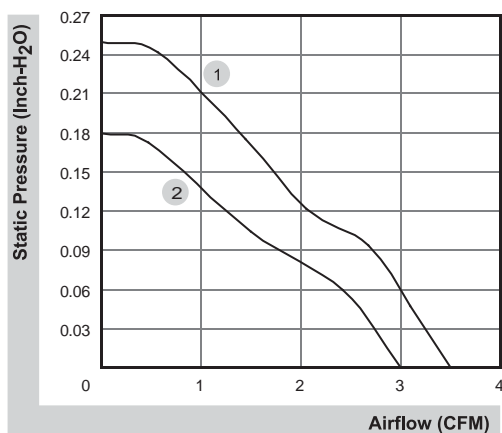

■ External dimensions(mm)

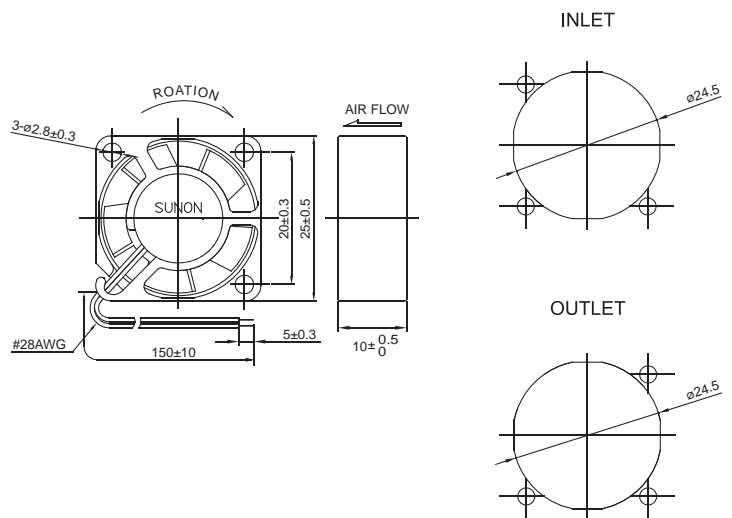

*All model could be customized. Please contact with Sunon Sales.

*Specifications are subject to change without notice. Please Visit SUNON website at <http://www.sunon.com> for update information.