

40W isolated DC-DC converter
Ultra-wide input and regulated single output

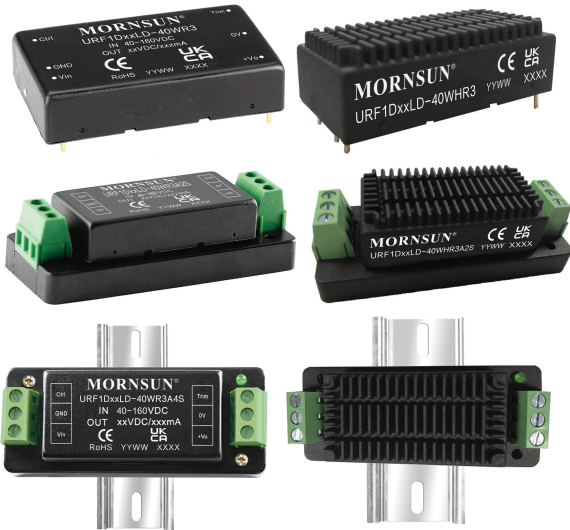

Patent Protection RoHS



EN62368-1 BS EN62368-1

URF1D_LD-40WR3 series of isolated 40W DC-DC converter products have an ultra-wide input voltage of 40-160VDC and feature efficiency of up to 91%. Meet reinforced isolation, input to output isolation is tested with 3000VDC/1500VAC and the converters safely operate in an ambient temperature of -40°C to +85°C. Input under-voltage protection, output short circuit, over-current, over-voltage, over-temperature protection. It is ideally suiting electronic equipment and railway vehicle applications using 72V, 96V and 110V battery voltages.

FEATURES

- Ultra-wide 4:1 input voltage range
- Reinforced isolation, I/O isolation test voltage 3.0KVDC/1.5KVAC
- Operating ambient temperature range: -40°C to +85°C
- Input under-voltage protection, output short-circuit, over-current, over-voltage protection, over-temperature protection
- Input reverse polarity protection available with chassis (A2S) or 35mm Din-Rail mounting (A4S) version
- Industry standard pin-out

Selection Guide

Certification	Part No. ①	Input Voltage (VDC)		Output		Full Load Efficiency ④ (%) Min./Typ.	Max. Capacitive Load(μF)
		Nominal ② (Range)	Max. ③	Voltage (VDC)	Current(mA) Max./Min.		
EN/BS EN	URF1D03LD-40WR3	110 (40-160)	170	3.3	10000/0	85/87	10000
	URF1D05LD-40WR3			5	8000/0	86/88	10000
	URF1D12LD-40WR3			12	3333/0	89/91	2700
	URF1D15LD-40WR3			15	2667/0	89/91	1680
	URF1D24LD-40WR3			24	1667/0	87/89	680
	URF1D48LD-40WR3			48	833/0	87/89	470

Note:
 ① Use "H" suffix for heat sink mounting, "A2S" suffix for chassis mounting and "A4S" suffix for Din-Rail mounting. We recommend to choose modules with a heat sink for enhanced heat dissipation and applications with extreme temperature requirements;
 ② Minimum input voltage and start-up voltage are increased by 1V for all models with A2S (wiring) and A4S (rail) suffixes because of the input reverse polarity function;
 ③ Exceeding the maximum input voltage may cause permanent damage;
 ④ Efficiency is measured at nominal input voltage and rated output load; efficiencies for A2S and A4S Model's is decreased by 2% due to the input reverse polarity protection.

Input Specifications

Item	Operating Conditions	Min.	Typ.	Max.	Unit
Input Current (full load / no-load)	Nominal input voltage	3.3V output	--	345/5	mA
		Others	--	413/3	
Reflected Ripple Current	Nominal input voltage	--	25	--	VDC
Surge Voltage (1sec. max.)		-0.7	--	180	
Start-up Voltage	100% load	--	--	40	
Input Under-Voltage Protection		28	32	--	
Start-up Time	Nominal input voltage & constant resistance load	--	20	--	ms
Input Filter		Pi filter			

Hot Plug		Unavailable			
Ctrl*	Module on	Ctrl pin open or pulled high (3.5-12VDC)			
	Module off	Ctrl pin pulled low to GND (0-1.2VDC)			
	Input current when off	--	2	10	mA

Note: *The Ctrl pin voltage is referenced to input GND.

Output Specifications

Item	Operating Conditions	Min.	Typ.	Max.	Unit	
Voltage Accuracy	0% -100% load	--	±1	±3	%	
Linear Regulation	Input voltage variation from low to high at full load	--	±0.4	±1		
Load Regulation	0% -100% load	--	±0.5	±1		
Transient Recovery Time		--	300	500	μs	
Transient Response Deviation	25% load step change, nominal input voltage	3.3V/5V output	--	±5	±8	%
		Others	--	±3	±5	
Temperature Coefficient	Nominal input voltage, full load	--	±0.02	±0.03	%/°C	
Ripple & Noise *	20MHz bandwidth, nominal input voltage, full load	--	150	200	mV p-p	
Trim		90	-	110	%Vo	
Over-voltage Protection	Input voltage range	110	--	160		
Over-current Protection		110	--	190		
Short-circuit Protection		Continuous, self-recovery				

Note: *Ripple & Noise at < 5% load is 5%Vo max. The "parallel cable" method is used for Ripple and Noise test, please refer to DC-DC Converter Application Note for specific information.

General Specifications

Item	Operating Conditions	Min.	Typ.	Max.	Unit
Isolation	Input-output Electric Strength Test for 1 minute with a leakage current of 1mA max.	3000	--	--	VDC
	Input-output Electric Strength Test for 1 minute with a leakage current of 5mA max.	1500	--	--	VAC
	Input/output-case Electric Strength Test for 1 minute with a leakage current of 1mA max.	1500	--	--	VDC
Insulation Resistance	Input-output resistance at 500VDC	1000	--	--	MΩ
Isolation Capacitance	Input-output capacitance at 100KHz/0.1V	--	2200	3000	pF
Operating Temperature	See Fig. 1	-40	--	+85	°C
Storage Temperature		-55	--	+125	
Over-temperature Protection		--	100	130	
Storage Humidity	Non-condensing	5	--	95	%RH
Pin Soldering Resistance Temperature	Soldering spot is 1.5mm away from case for 10 seconds	--	--	+300	°C
Switching Frequency*	PWM mode	--	220	--	KHz
Vibration		IEC61373 - Category 1, Grade B			
MTBF	MIL-HDBK-217F@25°C	500	--	--	K hours

Note: * Switching frequency is measured at full load. The module reduces the switching frequency for light load (below 50%) efficiency improvement.

Mechanical Specifications

Case Material	Aluminum alloy				
Dimensions	Without heat sink	Horizontal package	50.80 x 25.40 x 11.80 mm		
		A2S chassis mounting	76.00 x 31.50 x 21.20 mm		
		A4S Din-rail mounting	76.00 x 31.50 x 25.80 mm		
	With heat sink	Horizontal package	51.40 x 26.20 x 16.50 mm		
		A2S chassis mounting	76.00 x 31.50 x 25.30 mm		
		A4S Din-rail mounting	76.00 x 31.50 x 29.90 mm		

Weight	Without heat sink	Horizontal package/A2S chassis mounting/A4S Din-rail mounting	32.3g/56.3g/76.3g (Typ.)
	With heat sink	Horizontal package/A2S chassis mounting/A4S Din-rail mounting	41.0g/65.0g/85.0g (Typ.)
Cooling Method		Free air convection	

Electromagnetic compatibility (EMC) (EN62368)

Emissions	CE	CISPR32/EN55032	CLASS B(see Fig. 4-①/4-③ for recommended circuit)
	RE	CISPR32/EN55032	CLASS B (see Fig. 4-①/4-③ for recommended circuit)
Immunity	ESD	IEC/EN61000-4-2	Contact $\pm 6\text{KV}$ /Air $\pm 8\text{KV}$ perf. Criteria A
	RS	IEC/EN61000-4-3	20V/m perf. Criteria A
	EFT	IEC/EN61000-4-4	100kHz $\pm 4\text{KV}$ (see Fig.4-②/4-④ for recommended circuit) perf. Criteria A
	Surge	IEC/EN61000-4-5	line to line $\pm 2\text{KV}$ (2Ω 18uF see Fig.4-②/4-④ for recommended circuit) perf. Criteria A
	CS	IEC/EN61000-4-6	10 Vr.m.s perf. Criteria A

Electromagnetic Compatibility (EMC) (EN50155)

Emissions	CE	EN50121-3-2 150kHz-500kHz 99dBuV (see Fig. 4-①/4-③ for recommended circuit)
	RE	EN55016-2-1 500kHz-30MHz 93dBuV
Immunity	ESD	EN50121-3-2 Contact $\pm 6\text{KV}$ /Air $\pm 8\text{KV}$ perf. Criteria A
	RS	EN50121-3-2 20V/m perf. Criteria A
	EFT	EN50121-3-2 $\pm 2\text{kV}$ 5/50ns 5kHz (see Fig.4-②/4-④ for recommended circuit) perf. Criteria A
	Surge	EN50121-3-2 line to line $\pm 1\text{KV}$ (42Ω , $0.5\mu\text{F}$) (see Fig.4-②/4-④ for recommended circuit) perf. Criteria A
	CS	EN50121-3-2 0.15MHz-80MHz 10 Vr.m.s perf. Criteria A

Typical Characteristic Curves

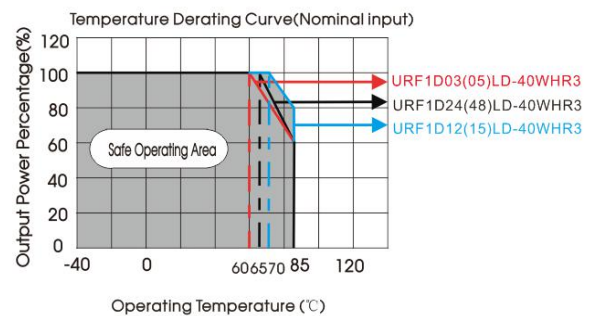
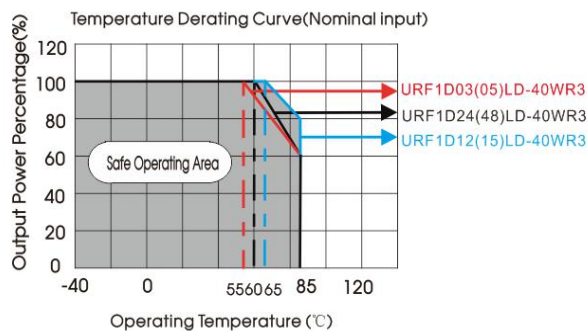

Fig. 1

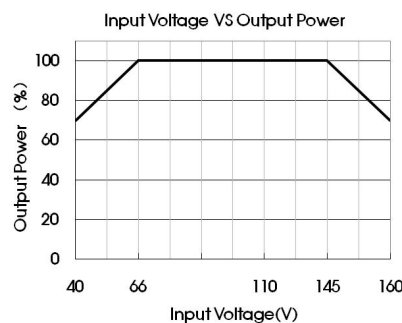
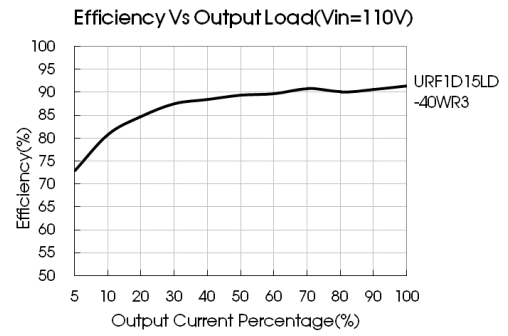
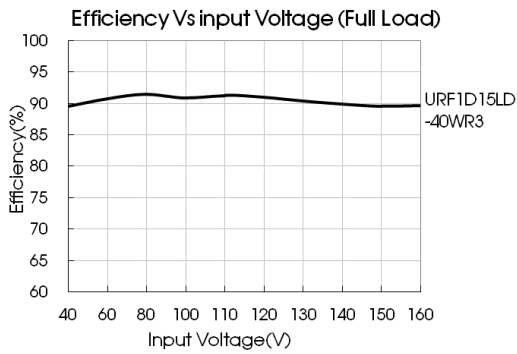
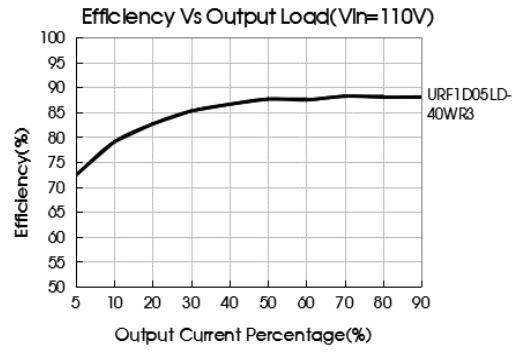
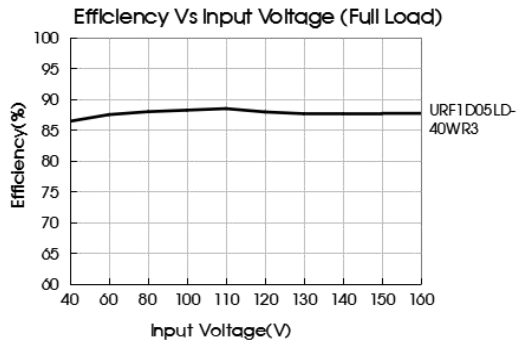

Fig. 2

Note:
Fig.2 Input voltage VS output power derating curve for reference only, when operating, as long as the case temperature does not exceed 100 °C, the product can be used under any conditions within the input voltage and output load range.



Design Reference

1. Typical application

All DC-DC converters of this series are tested before delivery using the recommended circuit shown in Fig. 3.

Input and/or output ripple can be further reduced by appropriately increasing the input & output capacitor values C_{in} and C_{out} and/or by selecting capacitors with a low ESR (equivalent series resistance). Also make sure that the capacitance is not exceeding the max. capacitive load value of the product.



Fig. 3

$V_{out}(VDC)$	Fuse	C_{in}	C_{out}
3.3, 5	2A, slow blow	100 μ F	470 μ F
12, 15			220 μ F
24, 48			100 μ F

2. EMC compliance circuit

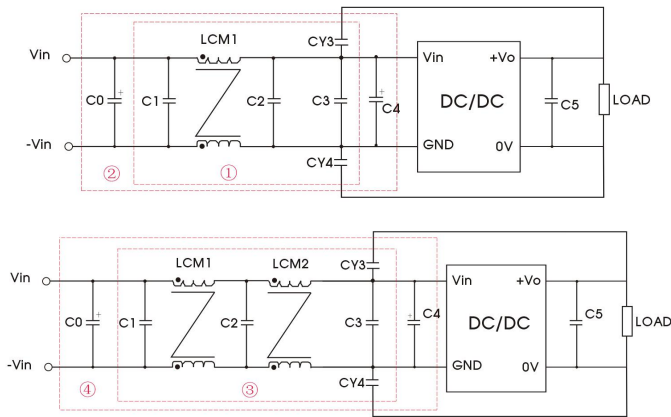

Fig. 4

Fig.4 List of components:

C0, C4	100µF/200V
C1, C2	2.2µF/250V
C3	Refer to the Cin in Fig.3
LCM1	10mH, recommended to use MORNSUN P/N: FL2D-30-103(C)
LCM2	2.2mH, recommended to use MORNSUN P/N: FL2D-30-222
CY3, CY4	2200pF/400VAC
C5	Refer to the Cout in Fig.3

Notes:

- For 3.3VDC, 5VDC, 12VDC, 15VDC, 24VDC output EMC tests we use Part ② in Fig. 4 for immunity and part ① for emissions test.
- For 48VDC voltage EMC tests we use Part ④ in Fig. 4 for immunity and part ③ for emissions test.

3. Trim Function for Output Voltage Adjustment (open if unused)

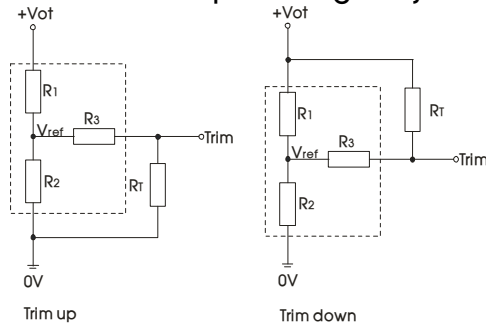

Calculating Trim resistor values:

$$\text{up: } R_T = \frac{\alpha R_2}{R_2 - \alpha} - R_3$$

$$\alpha = \frac{V_{ref}}{V_o' - V_{ref}} \cdot R_1$$

$$\text{down: } R_T = \frac{\alpha R_1}{R_1 - \alpha} - R_3$$

$$\alpha = \frac{V_o' - V_{ref}}{V_{ref}} \cdot R_2$$

R_T = Trim Resistor value;
 α = self-defined parameter;
 V_o' = desired output voltage

TRIM resistor connection (dashed line shows internal resistor network)

Vout(V)	R1(KΩ)	R2(KΩ)	R3(KΩ)	Vref(V)
3.3	4.801	2.87	10	1.24
5	2.883	2.87	10	2.5
12	11.000	2.87	15	2.5
15	14.384	2.87	15	2.5
24	24.872	2.87	17.8	2.5
48	55.28	3.0	20	2.5

4. Reflected Ripple Current testing circuit

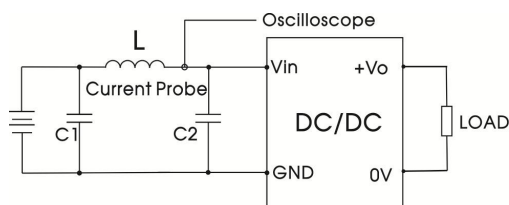

Fig.5

Fig.5 Parameter description:

C1	220µF, ESR<1.0Ω at 100KHz
L	4.7µH
C2	4.7µF/250V

5. The products do not support parallel connection of their output

6. For additional information please refer to DC-DC converter application notes on www.mornsun-power.com

Horizontal Package (without heat sink) Dimensions and Recommended Layout

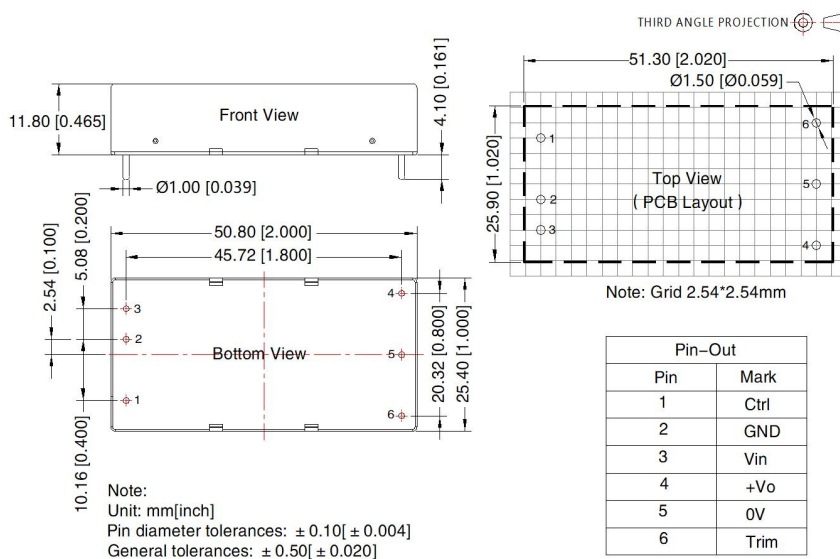

Horizontal Package (with heat sink) Dimensions

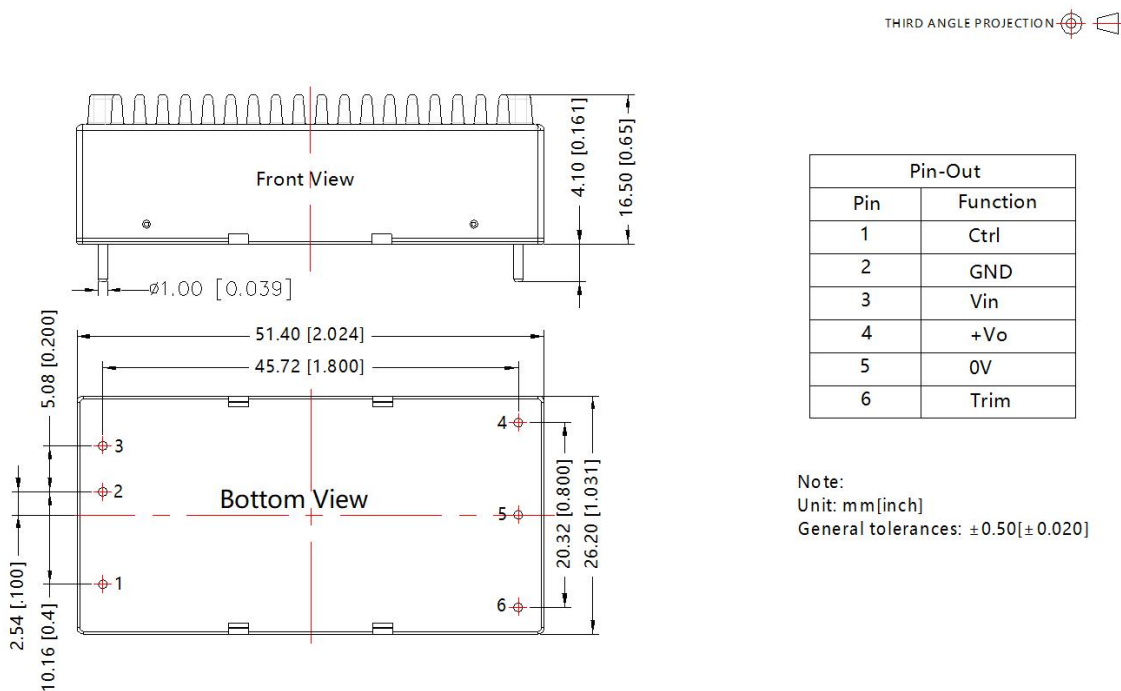

URF1D_LD-40WR3A2S (without heatsink) Dimensions

THIRD ANGLE PROJECTION 

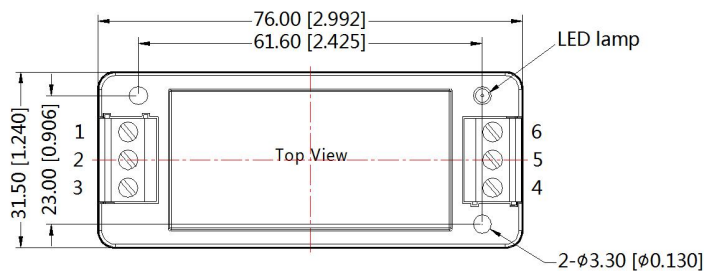

Pin-Out						
Pin	1	2	3	4	5	6
Function	Ctrl	GND	Vin	+Vo	0V	Trim

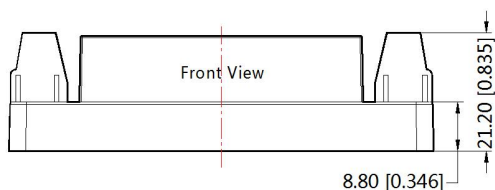

Note:
Unit: mm[inch]
Wire range: 24-12 AWG
Tightening torque: Max 0.4 N·m
General tolerances: ±0.50[±0.020]

URF1D_LD-40WHR3A2S (with heatsink) Dimensions

THIRD ANGLE PROJECTION 

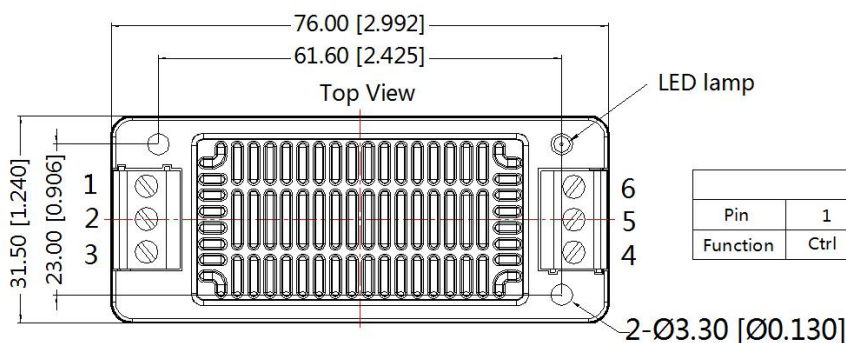

Pin-Out						
Pin	1	2	3	4	5	6
Function	Ctrl	GND	Vin	+Vo	0V	Trim

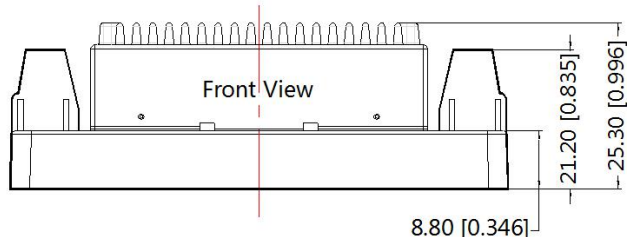

Note:
Unit: mm[inch]
Wire range: 24-12 AWG
Tightening torque: Max 0.4 N·m
General tolerances: ±1.00[±0.039]

URF1D_LD-40WR3A4S (without heatsink) Dimensions

THIRD ANGLE PROJECTION 

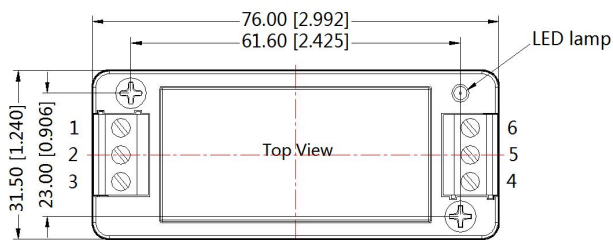

Pin-Out						
Pin	1	2	3	4	5	6
Function	Ctrl	GND	Vin	+Vo	0V	Trim

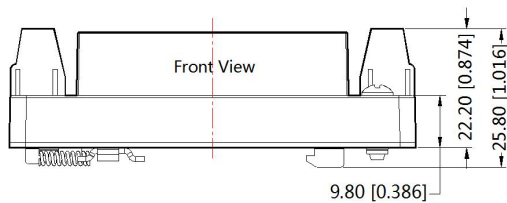

Note:
Unit: mm[inch]
Mounting rail: TS35
Wire range: 24-12 AWG
Tightening torque: Max 0.4 N·m
General tolerances: $\pm 1.00[\pm 0.039]$

URF1D_LD-40WHR3A4S (with heatsink) Dimensions

THIRD ANGLE PROJECTION 

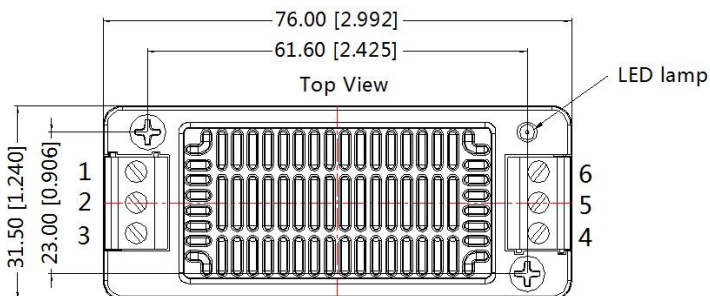

Pin-Out						
Pin	1	2	3	4	5	6
Function	Ctrl	GND	Vin	+Vo	0V	Trim

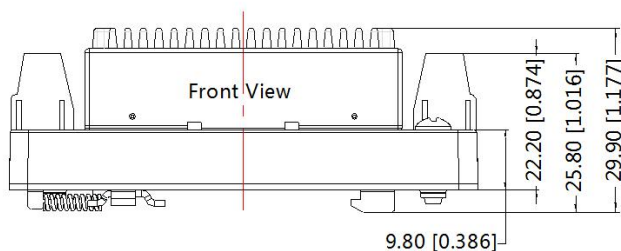

Note:
Unit: mm[inch]
Mounting rail: TS35
Wire range: 24-12 AWG
Tightening torque: Max 0.4 N·m
General tolerances: $\pm 1.00[\pm 0.039]$

Note:

1. For additional information on Product Packaging please refer to www.mornsun-power.com. The Packaging bag number of Horizontal packaging: 58200035(without heat sink), 58200051(with heat sink), A2S/ A4S packaging number: 58220022;
2. The maximum capacitive load offered were tested at input voltage range and full load;
3. Unless otherwise specified, parameters in this datasheet were measured under the conditions of $T_a=25^{\circ}\text{C}$, humidity<75%RH with nominal input voltage and rated output load;
4. All index testing methods in this datasheet are based on company corporate standards;
5. Other product application information, please see DC-DC (railway power supply) Converter Application Notes for specific operation methods;
6. We can provide product customization service, please contact our technicians directly for specific information;
7. Products are related to laws and regulations: see "Features" and "EMC";
8. Our products shall be classified according to ISO14001 and related environmental laws and regulations, and shall be handled by qualified units.

Mornsun Guangzhou Science & Technology Co., Ltd.

Address: No. 5, Kehui St. 1, Kehui Development Center, Science Ave., Guangzhou Science City, Huangpu District, Guangzhou, P. R. China

Tel: 86-20-38601850

Fax: 86-20-38601272

E-mail: info@mornsun.cn

www.mornsun-power.com