

## DUAL LOW NOISE EQUALIZER AMPLIFIER

The KA2221 is a monolithic integrated circuit consisting of 2-channel low noise amplifiers and regulated power supply for car stereos.

### FEATURES

- Suitable for car stereos.
- Low noise amplifier.
- Voltage regulator included.
- Good ripple rejection.
- High channel separation (65dB Typ).
- Minimum number of external parts required.

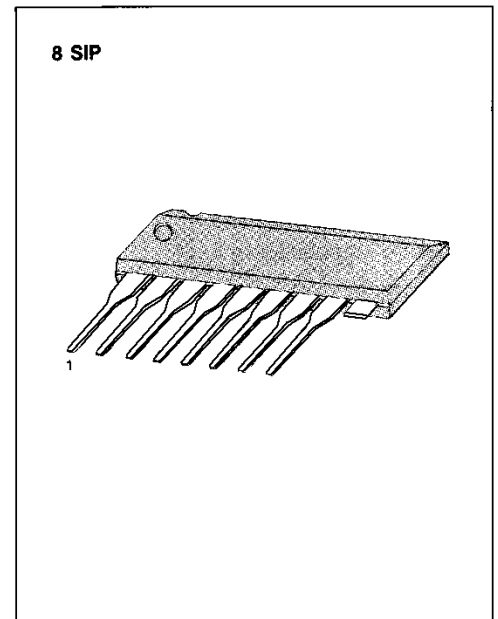

### ORDERING INFORMATION

Device	Package	Operating Temperature
KA2221	8 SIP	-20°C ~ +70°C

### BLOCK DIAGRAM

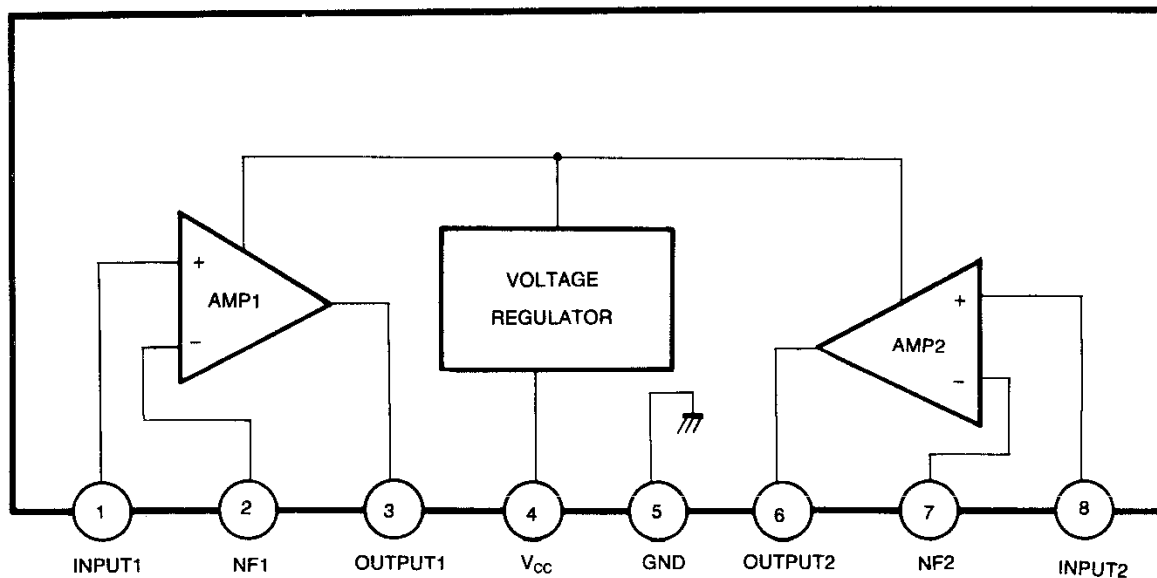

Fig. 1

### ABSOLUTE MAXIMUM RATINGS (T<sub>a</sub> = 25°C)

Characteristic	Symbol	Value	Unit
Supply Voltage	V <sub>CC</sub>	18	V
Power Dissipation	P <sub>D</sub>	200	mW
Operating Temperature	T <sub>OPR</sub>	- 20 ~ + 70	°C
Storage Temperature	T <sub>STG</sub>	- 40 ~ + 125	°C

### ELECTRICAL CHARACTERISTICS

(T<sub>a</sub> = 25°C, V<sub>CC</sub> = 12V, R<sub>L</sub> = 10KΩ, f = 1KHz, NAB, unless otherwise specified)

Characteristic	Symbol	Test Conditions	Min	Typ	Max	Unit
Quiescent Circuit Current	I <sub>CCO</sub>	V <sub>I</sub> = 0		6.0	9.0	mA
Open Loop Voltage Gain	G <sub>VO</sub>		65	80		dB
Closed Loop Voltage Gain	G <sub>VC</sub>	V <sub>O</sub> = 0.5V	33	35	37	dB
Output Voltage	V <sub>O</sub>	THD = 1%	0.6	1.0		V
Total Harmonic Distortion	THD	V <sub>O</sub> = 0.5V		0.1	0.3	%
Input Resistance	R <sub>I</sub>			150		KΩ
Equivalent Input Noise Voltage	V <sub>NI</sub>	R <sub>G</sub> = 2.2KΩ BW (- 3dB) = 15Hz ~ 30KHz		1.0	2.0	μV
Cross Talk	CT	R <sub>G</sub> = 2.2KΩ	50	65		dB

### TEST CIRCUIT

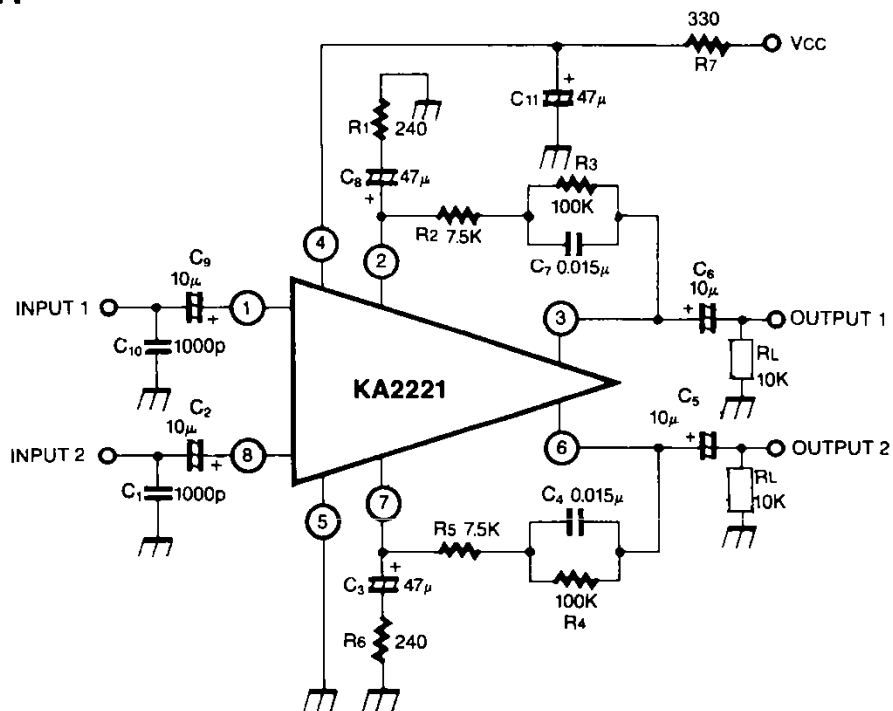
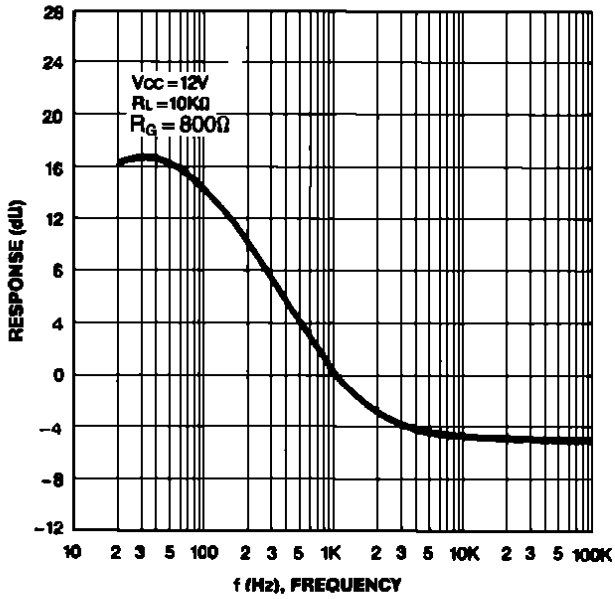
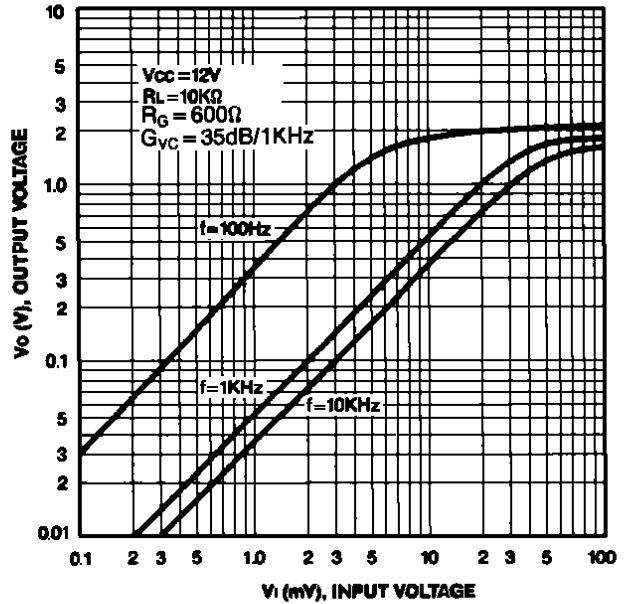

Fig. 2

**FREQUENCY RESPONSE**



**OUTPUT VOLTAGE-INPUT VOLTAGE**



**CROSS TALK-FREQUENCY**

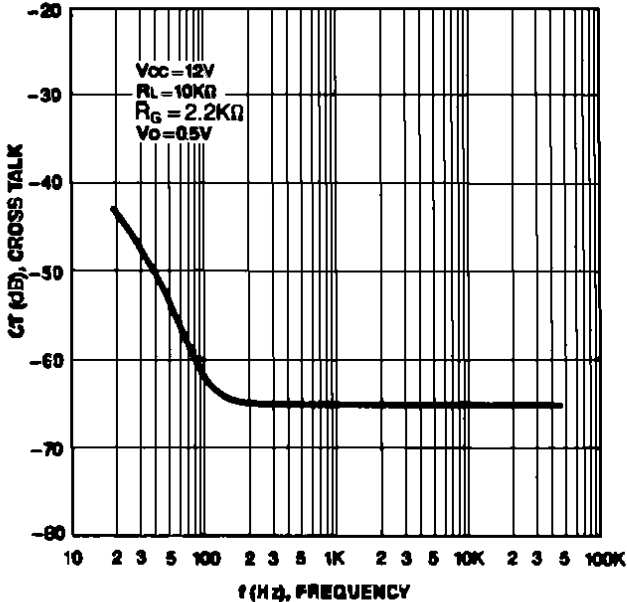

**OUTPUT VOLTAGE-SUPPLY VOLTAGE**

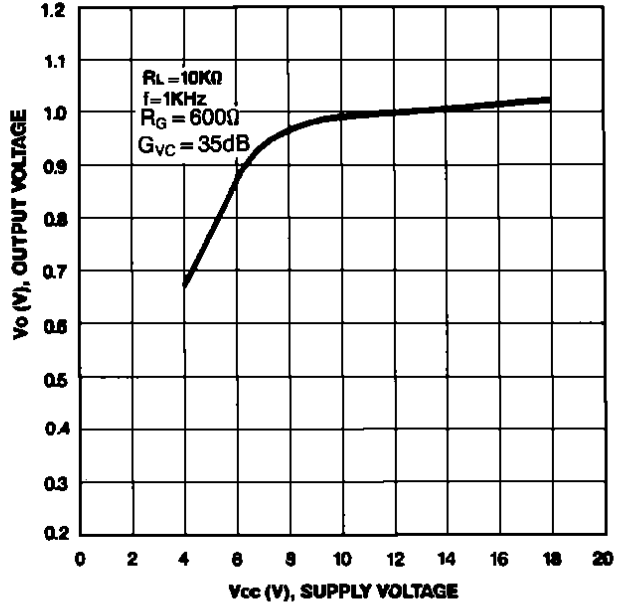

**TOTAL HARMONIC DISTORTION-OUTPUT VOLTAGE**

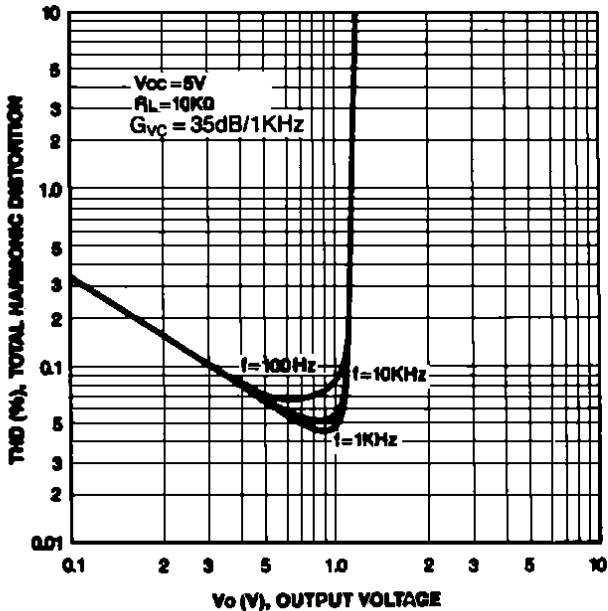

**QUIESCENT CIRCUIT CURRENT-SUPPLY VOLTAGE**

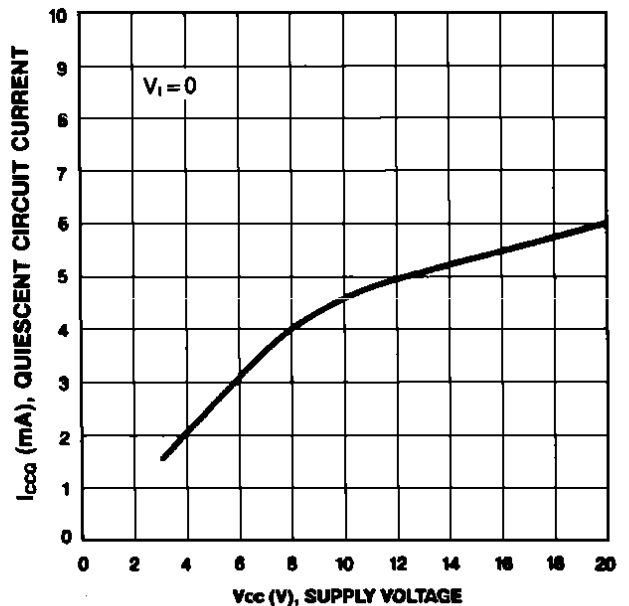

## APPLICATION INFORMATION

### External Components (Refer to test circuits)

C<sub>1</sub> (C<sub>10</sub>): Noise filter

These capacitors prevent radio interference in strong electric fields. The recommended value is 1000pF.

C<sub>2</sub> (C<sub>9</sub>): Input coupling capacitor

The recommended value is 10μF. If made too small, the low frequency characteristics will change for the worse, but too large a value will increase the rising time when power is applied.

C<sub>3</sub> (C<sub>8</sub>): Negative feedback capacitor

The lower cut-off frequency depends on the value of these capacitors and is determined as follows:

$$C_3 (C_8) = \frac{1}{2\pi f_L \cdot R_1 (R_6)}$$

f<sub>L</sub>: Low cut-off frequency

If the value of these capacitors is made larger, the starting time of amplifier is delayed further.

C<sub>5</sub> (C<sub>6</sub>): Output coupling capacitor

The recommended value is 10μF.

R<sub>2</sub>, R<sub>3</sub>, C<sub>7</sub> (R<sub>4</sub>, R<sub>5</sub>, C<sub>4</sub>): Equalizer network

The time constants of standard NAB characteristic are follow.

Tape speed	9.5cm/sec	4.75cm/sec
C <sub>7</sub> (R <sub>2</sub> + R <sub>3</sub> )	3180μsec	1590μsec
R <sub>2</sub> , C <sub>7</sub>	90μsec	120μsec

R<sub>1</sub> (R<sub>6</sub>): Feedback component

The closed loop gain is determined approximately by the following relationship.

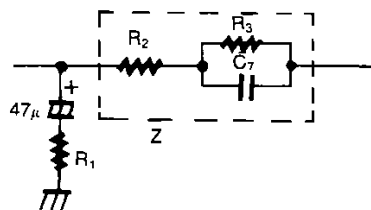

$$G_{VC} = 20 \log \frac{Z + R_1}{R_1} \quad (\text{dB})$$

$$Z = R_2 + R_3 // C_7$$

\* Choose R<sub>2</sub>, R<sub>3</sub>, (DC resistance of NAB element) as 100KΩ approximately.